

**Non-Contact
Infrared Thermometer
Handheld Models**

NEW IT-545 Series
IT-550 Series



CE marking compliant



IT-550 (Actual size)



IT-545 (Actual size)



Quick, Accurate and Easy

A full lineup of hand-held infrared thermometers covering a wide range of measurement needs

Every unit offers reliable functionality, narrow focus, splash resistance and low cost with exceptional performance. We have the ideal model to meet your specific temperature measurement needs.

Non-Contact

Infrared Thermometer Handheld Models

Narrow-focus model

IT-550F

-50°C ~ 500°C

AC adaptor, tripod

Twin beam marker

Digital output (Option)

Printer output (Option)

Splash-resistant

Memory function

IT-550L

-50°C ~ 500°C

AC adaptor, tripod

Twin beam marker

Digital output (Option)

Analog output (Option)

Splash-resistant

Display resolution switch

NEW IT-545N

-50°C ~ 500°C

Twin beam marker

Upper/Lower temp alarm

Measurement-hold function

NEW IT-545NH

-50°C ~ 1000°C

Twin beam marker

Upper/Lower temp alarm

Measurement-hold function

Spot focus model

IT-550S

-50°C ~ 500°C

AC adaptor, tripod

Twin beam marker

Digital output (Option)

Analog output (Option)

Splash-resistant

Display resolution switch

NEW IT-545S

-50°C ~ 500°C

LED target marker

Upper/Lower temp alarm

Measurement-hold function

ø20

500

ø40

500

ø2.5

73

ø2.5 ø32.4

30 100

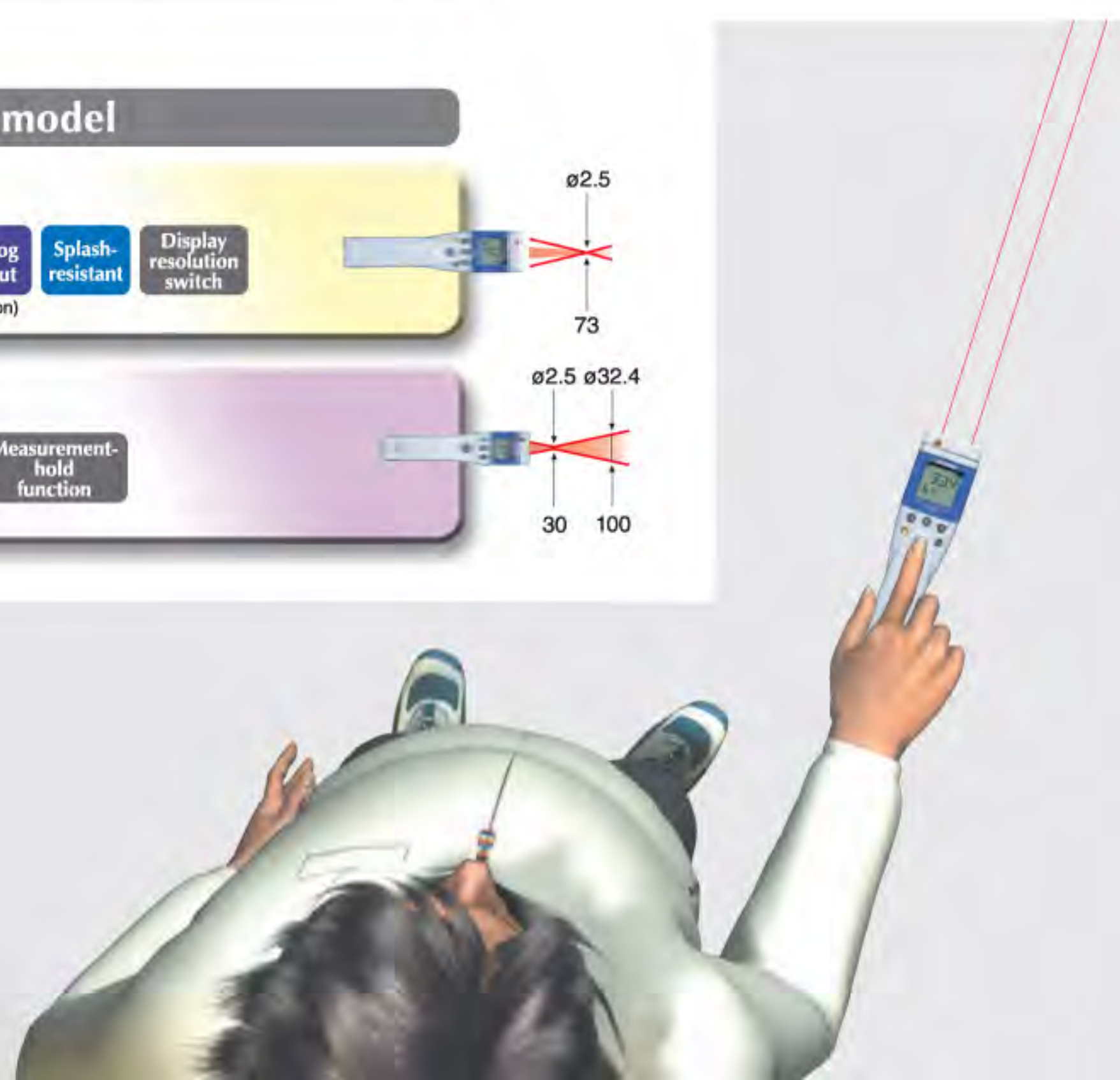

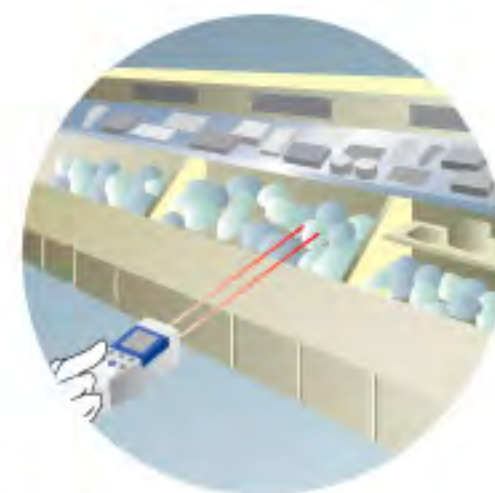
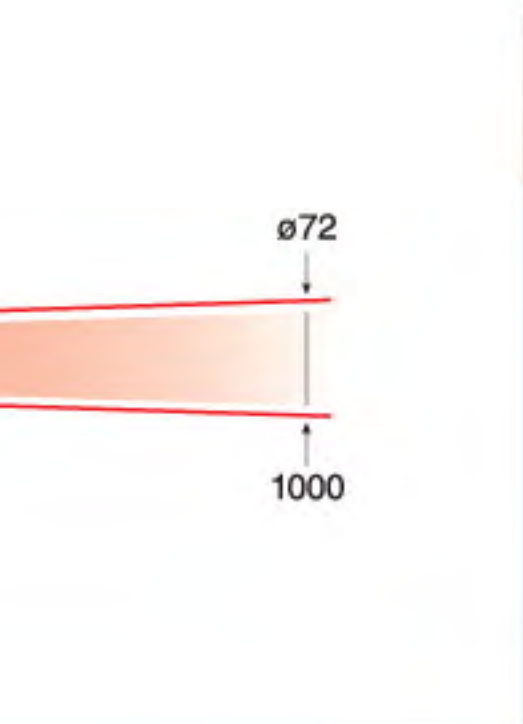
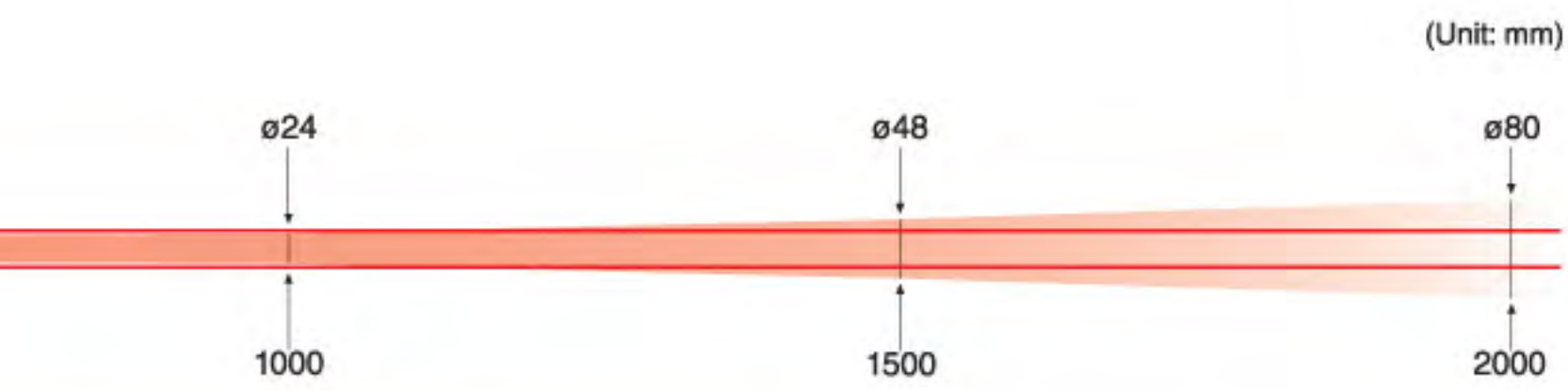
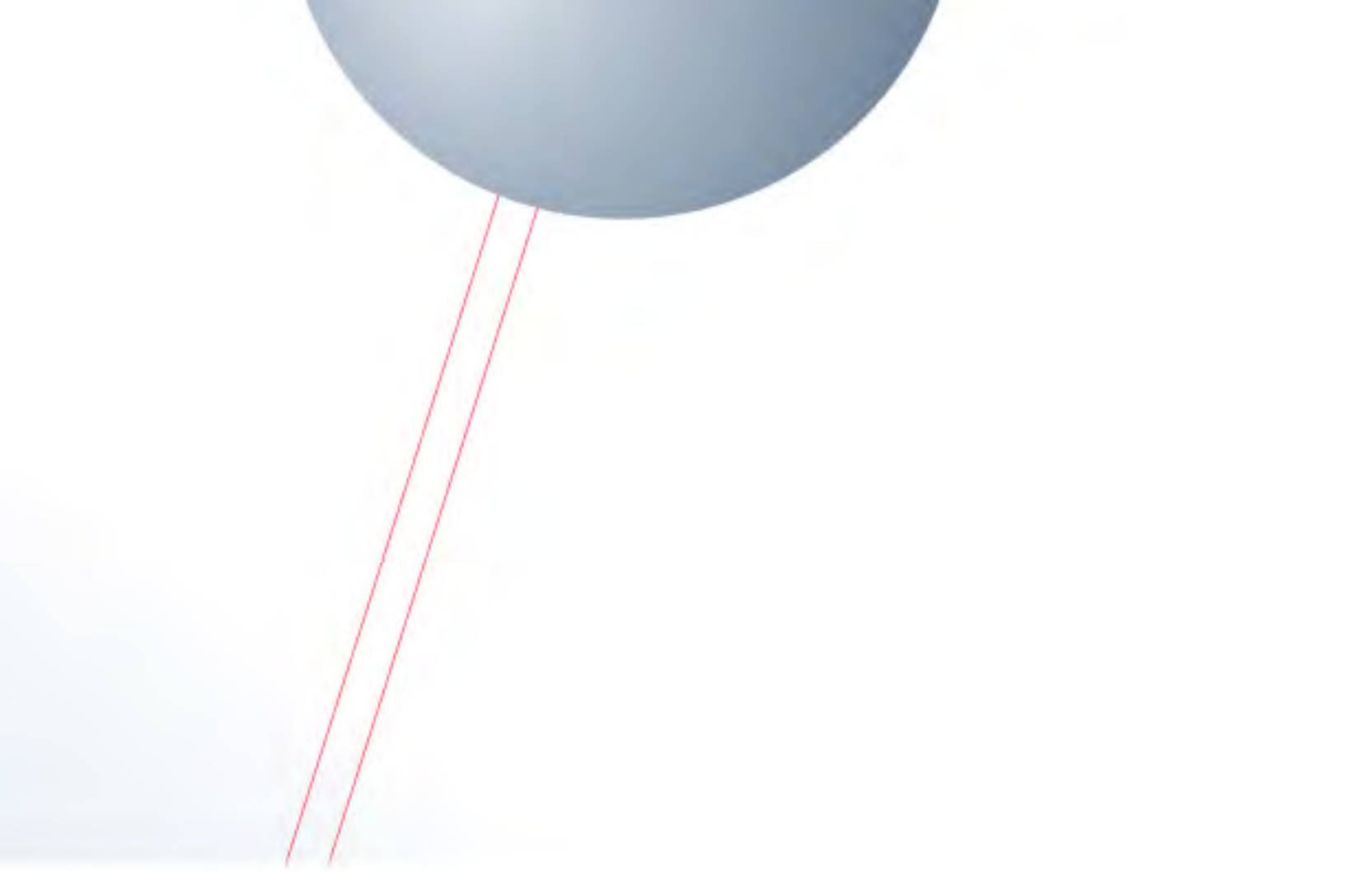

Food temperature management

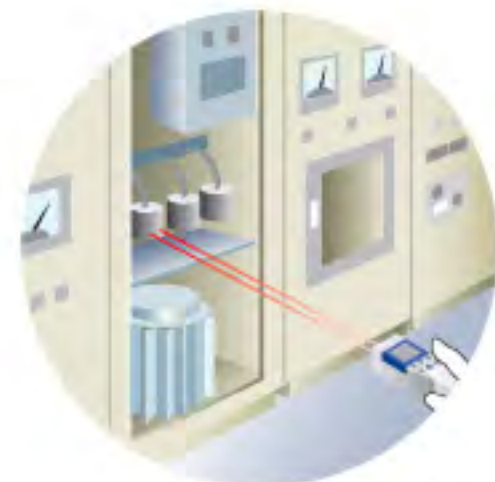

Non-contact testing of high-voltage equipment such as a power supply system



Temperature measurement as a part of lab tests



Surface temperature measurement of ICs and other minute surfaces



Refrigeration maintenance of foods



Temperature check when adding or removing food from storage

Infrared Thermometer Applications

ELECTRIC / ELECTRONIC

• Copiers

To identify overheating during regular maintenance.

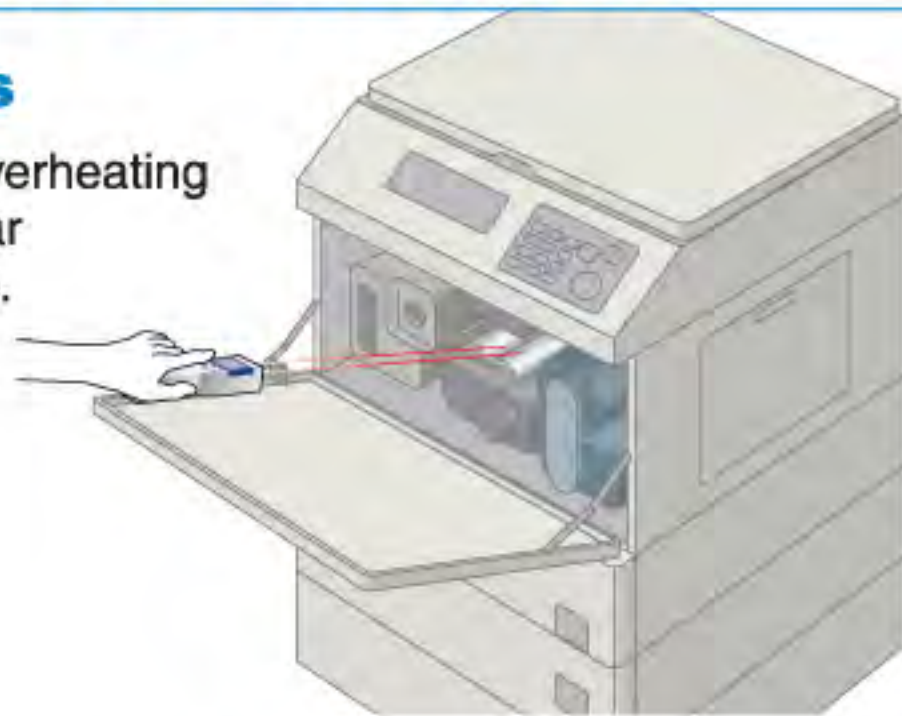

• Electronic components

Check for abnormal heating while an object is in use. Spot infrared thermometers (IT-545S/IT-550S) can measure temperatures of very small parts.

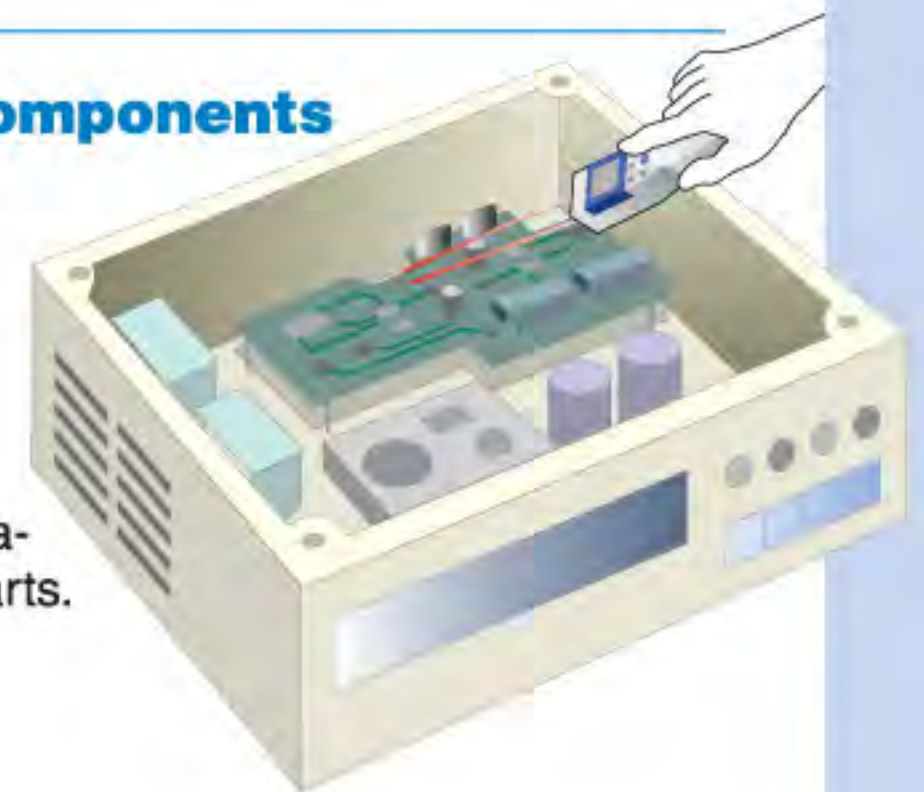

SAFETY / MAINTENANCE

• Piping

Check for overheating or freezing. Infrared thermometers can inspect different points easily and quickly.

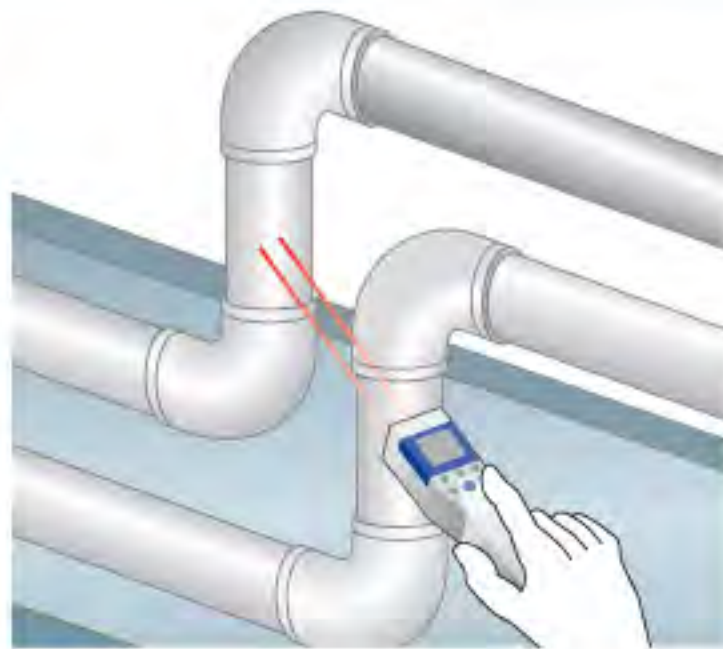

• Elevator machine room

Overheating inspection of the operator motor and other parts during regular maintenance.

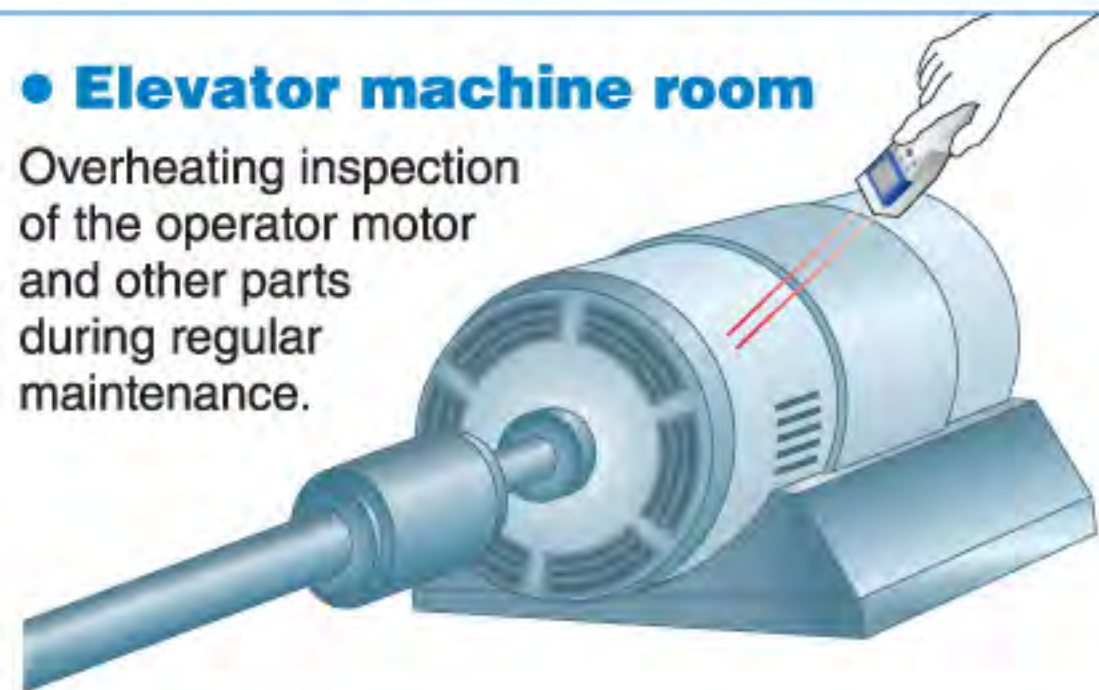

FOODS

• Ovens and dryers

Temperature control in baking and other process is crucial. Non-contact measurement is sanitary and leads to quality improvement.

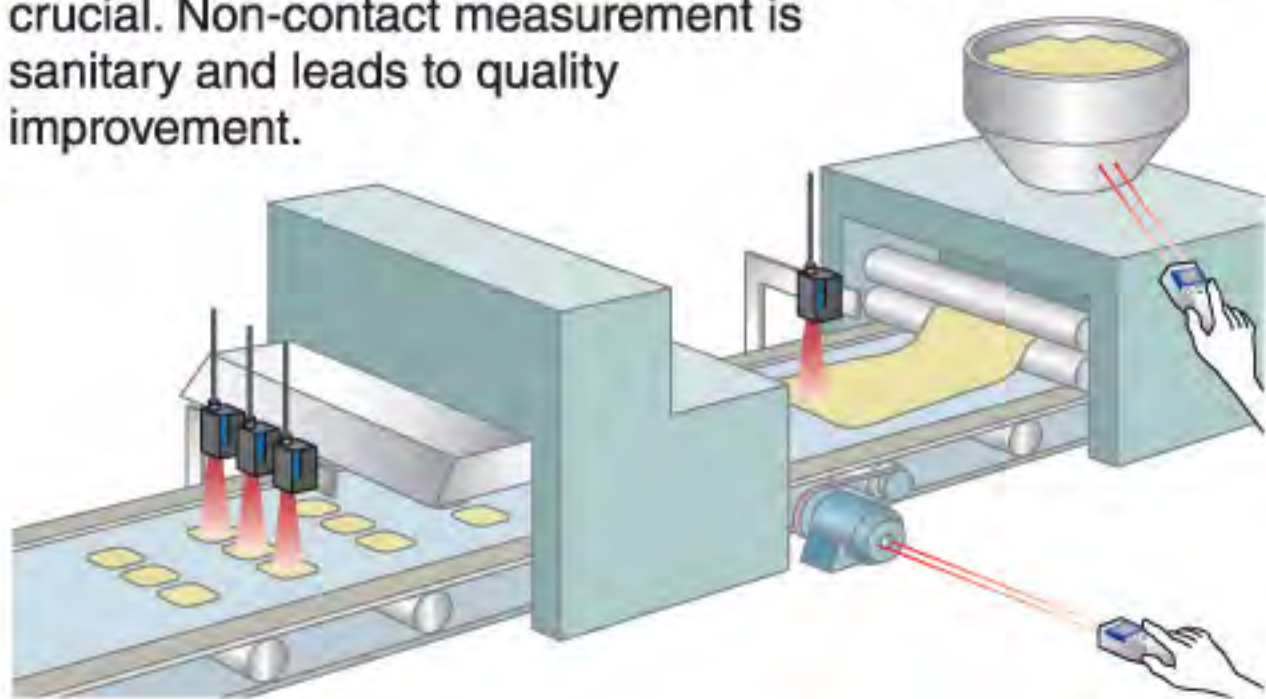

CONSTRUCTION / CIVIL ENGINEERING

• Thermal insulation

For R&D, comparison and inspection of insulators.

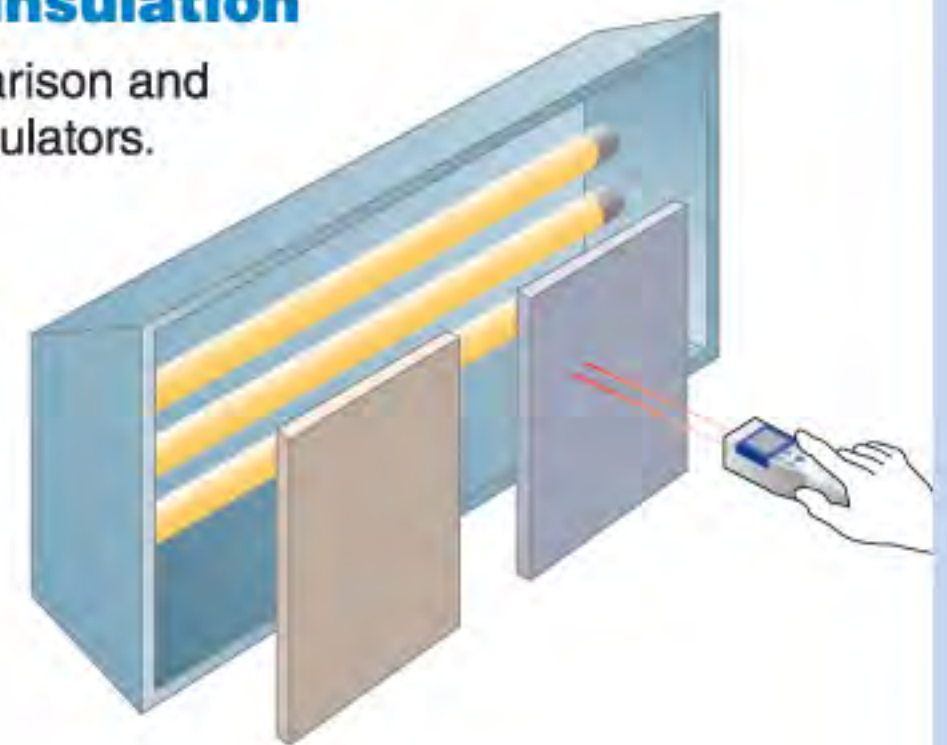

OTHERS

- Inspection of household appliances.
- Inspection of air conditioners.
- Temperature monitoring of electric motors.
- Thermal insulation tests for pots and steamers.
- Inspection of ironing surface.
- Periodic maintenance of HVACR.
- Periodic maintenance of furnace outer wall.
- Periodic maintenance of boiler outer wall.
- Temperature inspection of refrigerated / frozen foods.
- Cooking temperature inspection.
- Deep fryer oil temperature inspection.
- Detecting overheating parts of automobile.
- Inspection of automobile air conditioners.
- Temperature measurement of automobile headlights.

Non-Contact Infrared Thermometer

NEW

IT-545 Series



CE marking compliant

Easy-to-carry, compact & lightweight design

**Simple,
advanced design**

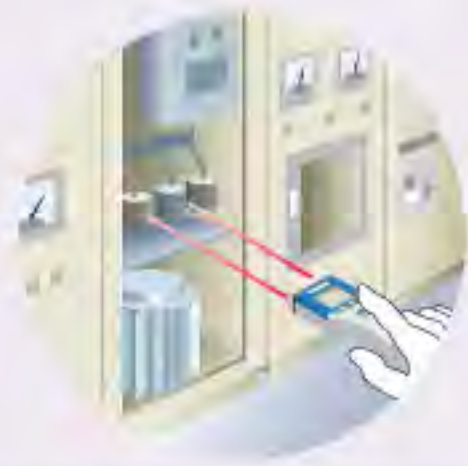

For routine maintenance work
**Narrow-focus model
(Twin beam model)**



- Quick, accurate readings, even under rapidly changing ambient temperatures minimizing "temperature drift."
- Wide measurement area
- Abnormal temperature warning by audio alarm and flashing marker*.

* Only for models designated NH and N.



For measuring electronic components
Spot focus model

Narrow-focus model

Spot focus model

IT-545NH

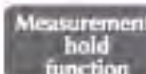
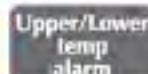

IT-545N

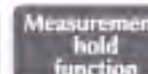
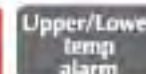

IT-545S

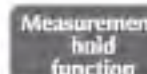
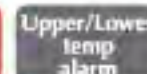

Spectral response	8 to 14µm	
Measurement temp. range**	-50 to 1000°C	-50 to 500°C
Display temp. range	-55 to 1010°C	
Display resolution	0.1°C for 0.0 to 199.9°C 1°C for other than above	
Accuracy*2	-50 to -0°C	±(10% of reading -1.5)°C
	0.0 to 199.9°C	±1.0°C
	200 to 500°C	±(0.5% of reading +0.5)°C
	501 to 1000°C	±(0.5% of reading +0.5)°C (Only for IT-545NH)
Repeatability	-50 to -0°C	±1°C
	0.0 to 199.9°C	±0.3°C
	200 to 500°C	±1°C
	501 to 1000°C	±1°C (Only for IT-545NH)
Response time	Within 0.8sec (95%)	
Target size	ø40/500 mm (DS*3 12.5:1)	ø2.5/30 mm
Emissivity setting	0.10 to 1.00 in 0.01 increments	
Sight	Twin beam laser marker (Class 2)	LED spot marker
Operating temp. & humidity	0 to 50°C, 35 to 85% RH, no condensation	
Power	AAA batteries × 4	
Battery life	Approx. 8 hrs (continuous use under standard condition using manganese battery)	Approx. 25 hrs (continuous use under standard condition using manganese battery)
Dimensions / Mass	40(W) × 170(L) × 36(H) mm / Approx. 140g (batteries included)	
Other functions	Upper/Lower temp alarm (between -55 and 1010°C) Max/Min values Measurement-hold Auto power off	Upper/Lower temp alarm (between -55 and 505°C) Max/Min values Measurement-hold Auto power off
Accessories	AAA batteries × 4, carrying case, manual	

*1: Fahrenheit and Celsius displays are available for the Americas.

*2: Temp. 18°C to 28°C, Humidity 55%RH, Emissivity (ε)=1.00

*3: DS = Distance to spot size

Non-Contact Infrared Thermometer

IT-550 Series

CE
CE marking compliant

Narrow Focus, Splash-Resistance & Digital Output
The Twin-Laser Sight Makes Measurements A Snap!

Narrow-focus type

Target area of $\varnothing 24/1000$ mm (F and L models)

The twin laser sight makes it easy to focus on target. The F (Field) model, L (Lab) model and the S (Spot) model all have unique twin-laser sights optimized for your applications. The F and L models require only 1/3 of target area, when compared to older models, making it easier to measure temperature of small objects from a distance. The S model's target area is $\varnothing 2.5/73$ mm.

Splash-resistance

The splash-resistant non-contact thermometer!

IT-550 is splash-resistant. It can be safely used in kitchens and other type of spaces where thermometers may get wet. It can safely be operated with a wet hand, making it ideal for use in food industry.



* A wet lens can cause errors in readings. Completely wipe off any water from the lens before use.



IT-550F
IT-550L
IT-550S

Digital Output

Memory function, Digital Output, Voltage Output, PC/Printer connection and more!
Speedup data processing by collecting temperature measurements directly from the thermometer!

The expansion kit (option) lets you connect the thermometer (F model) to printers and print data directly from its memory. The thermometers with digital/voltage output (L & S models) can easily hookup to a computer/recorder and export data for spreadsheets or word processors.

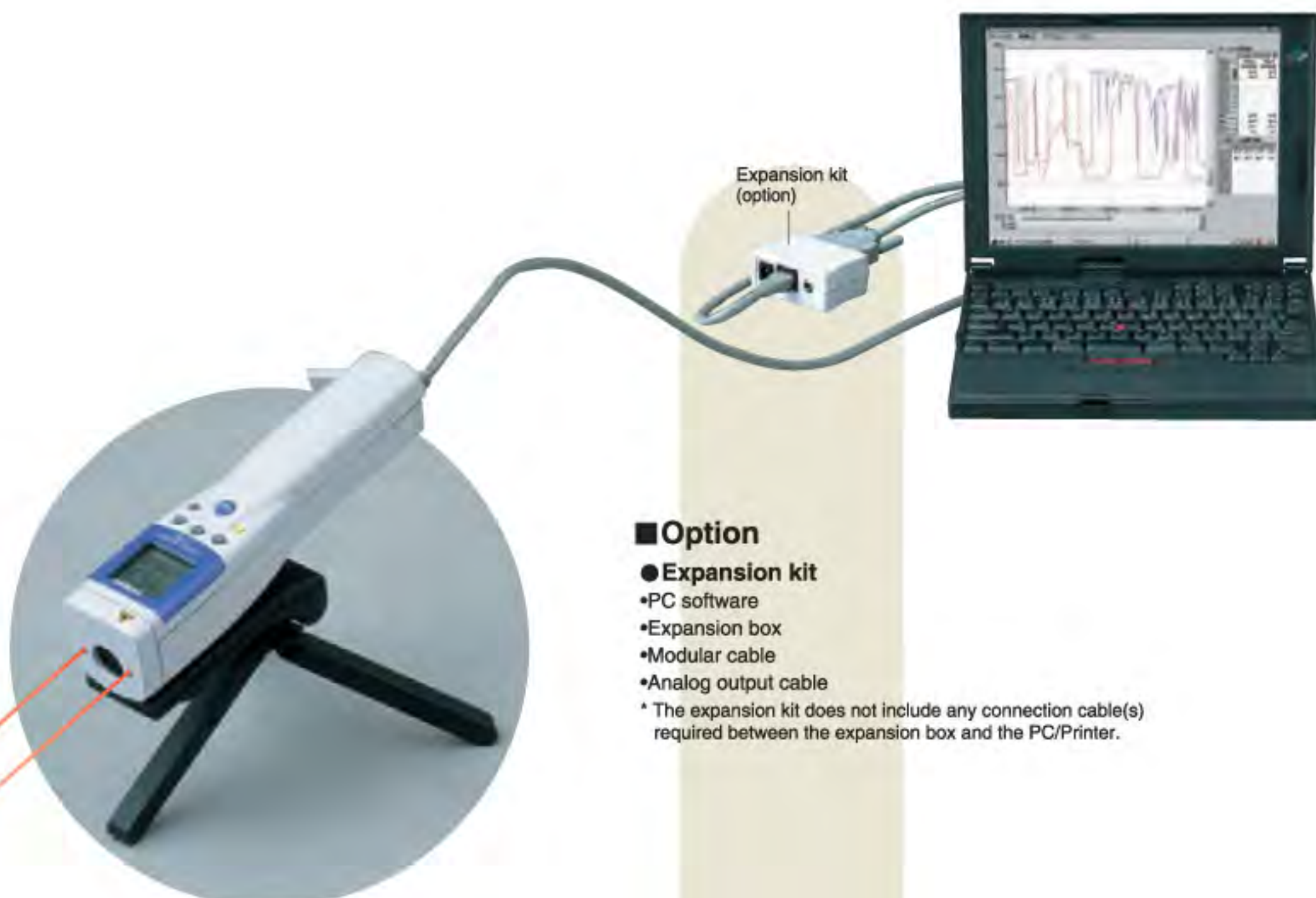
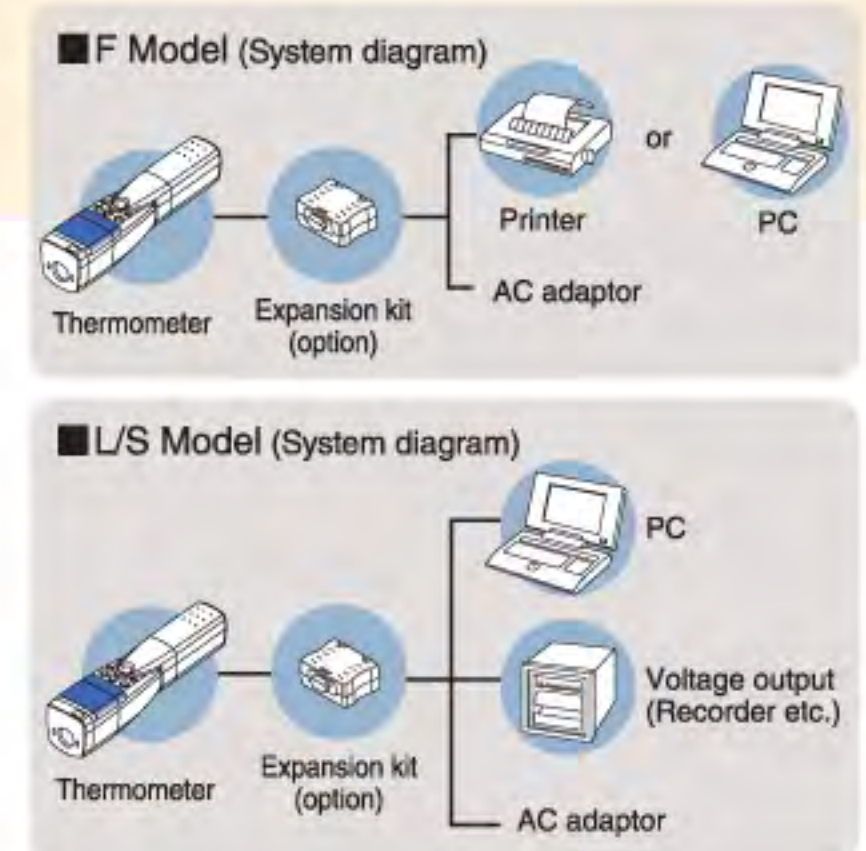

Option

● Expansion kit

- PC software
- Expansion box
- Modular cable
- Analog output cable

* The expansion kit does not include any connection cable(s) required between the expansion box and the PC/Printer.

Graphing made easy

● Using the accompanied software (L & S modes)

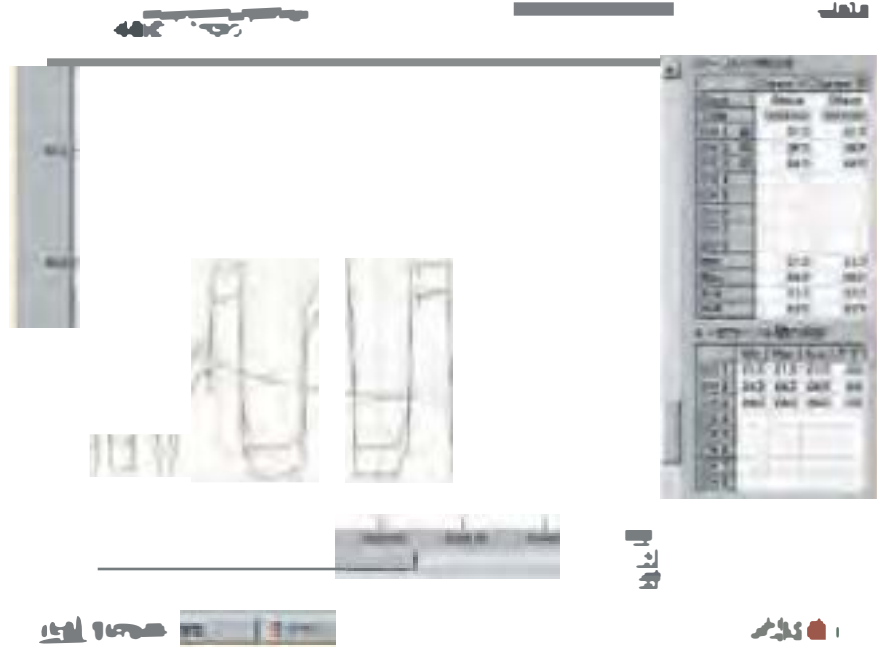

▲ Sample screen

● Exporting data to spreadsheets (all models)

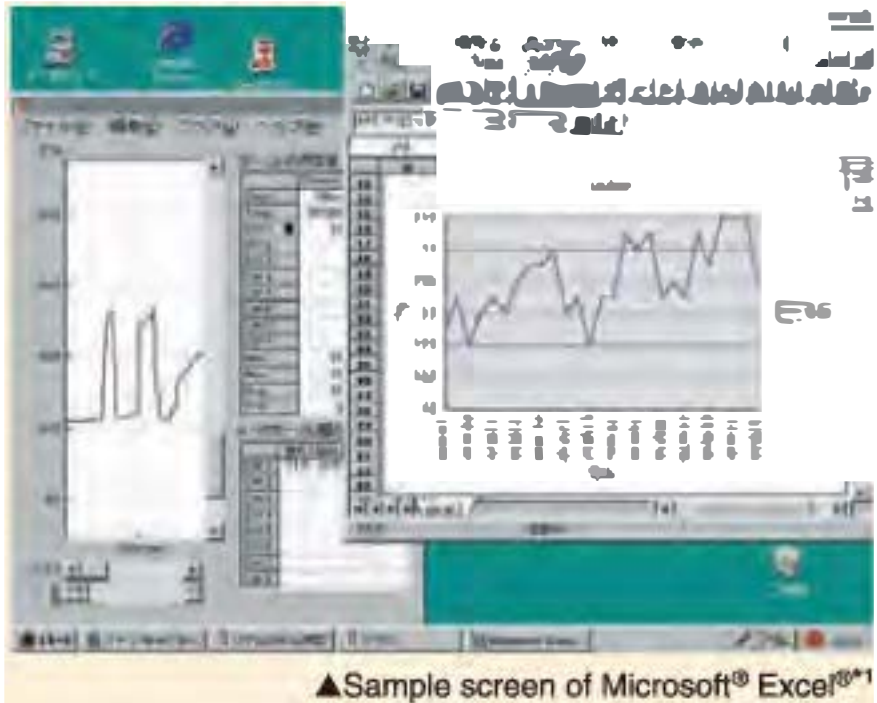

▲ Sample screen of Microsoft® Excel®

Obtaining hardcopy



▲ Sample printer

Simplifying reports



▲ Sample report

Data manipulations

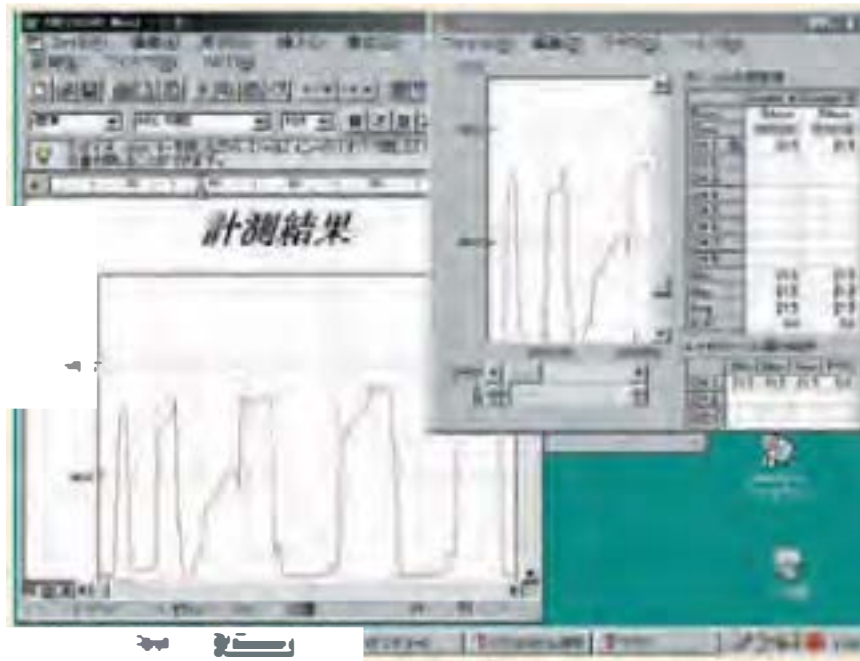

Using a graphical recorder

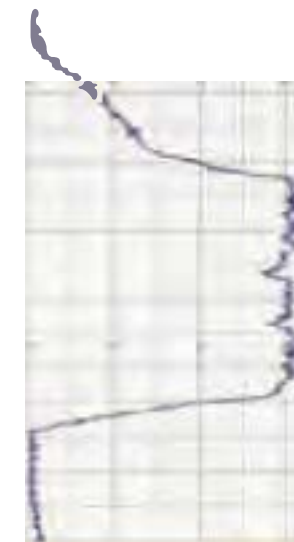

▲ Sample graph

Power supply maintenance

For Field Use

IT-550F



Various temperature measurements in lab testing

For laboratory Use

IT-550L



Surface temperature measurements of minute devices such as IC components

For laboratory Use. Spot Focus Model

IT-550S



Spectral response	8 to 16 μ m	
Measurement temp range	-50 to 500°C	
Display temp. range (Display resolution)	-55.0 to 505.0°C (0.1°C)	55.0 to 505.0°C (1°C) or -55.0 to 505.0°C (0.1°C)
Accuracy	±(10% of reading -2)°C (-50.0 to -0.1°C) ±2.0°C (0.0 to 200.0°C) ±1% of reading (200.0 to 500.0°C) (Temp. 18 to 28°C Humidity 55%RH, $\epsilon=1.00$)	±(10% of reading -2)°C (-50.0 to 1°C) or (-50.0 to 0.1°C) ±2.0°C (0.0 to 200.0°C) or (0.0 to 200.0°C) ±1% of reading (200.0 to 500.0°C) or (200.0 to 500.0°C) (Temp. 18 to 28°C Humidity 55%RH, $\epsilon=1.00$)
Repeatability	±1°C (-50.0 to -0.1°C) ±0.5°C (0.0 to 500.0°C)	[0.1°C resolution] ±1°C (-50.0 to -0.1°C), ±0.5°C (0.0 to 500.0°C) [1°C resolution] ±2°C (-50 to -1°C), -2°C (-50 to -1°C)
Response time	Within 1.6 sec (95%)	0.7 sec or less (95%) at 1°C resolution; 1.6 sec or less (95%) at 0.1°C resolution
Target size	ø24/1000 mm (DS 41.6:1)	ø2.5/73 mm
Emissivity setting	0.10 to 1.00 in 0.01 increments	
Sight	Twin beam laser marker (Class 2)	
Splash & Dust resistance	IP54 (IEC529)	
Operating temp & humidity	0 to 40°C, 35 to 85% RH, no condensation	
Power	9 V dry battery (6F22 or 6LR61) X 1, or AC adapter (requires the expansion kit)	
Battery life	Approx. 20 hrs (continuous use under standard condition using alkaline battery)	
Dimensions / Mass	47(W) X 200(L) X 48(H) mm / Approx. 280g (battery included)	
Other functions	Date memory (Max.130point), Printer output, RS232C Max/Min values, Measurement hold, Auto power off	Analog output (0 to 1v), Display resolution, Scaling, RS232C Max/Min values, Measurement hold, Auto power off
Accessories	Manual, carrying case, hand strap, battery, battery opener	

TASHIKA CO., LTD.

1-12, Kaiyo-cho, Ashiya, 659-0035, JAPAN
Tel: +81-797-23-9035 Fax: +81-797-23-2105
e-mail: sales@tashika.co.jp URL: www.tashika.co.jp

Note: The expansion kit (Option) is required for analog output, printer output, use of RS232C
*1: Microsoft and Excel are registered trademarks of Microsoft Corporation in the United States and other countries